

# Badger

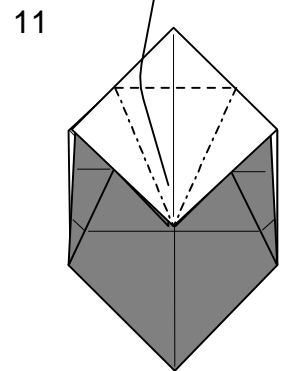

Repeat steps 4 to 9 on the left side

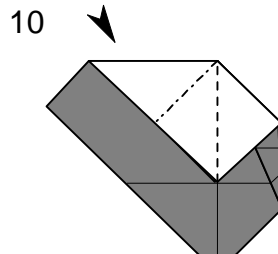
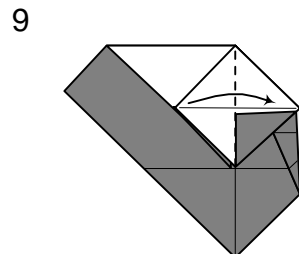
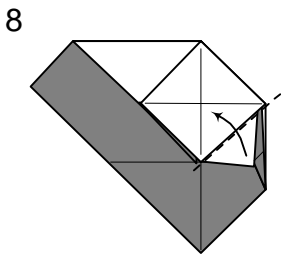
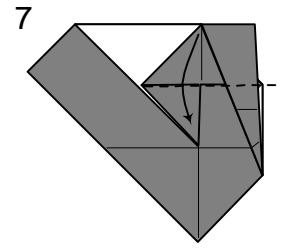
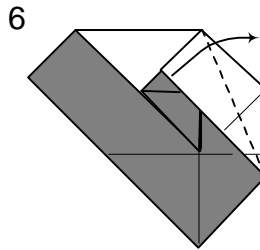
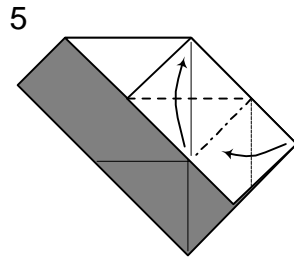
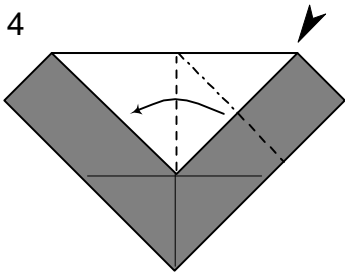
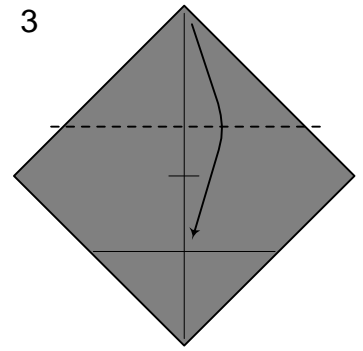
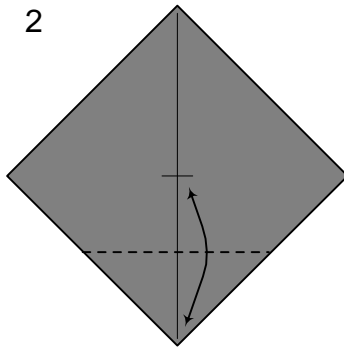
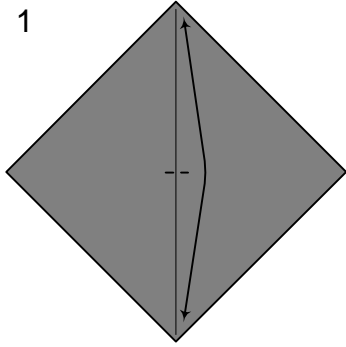
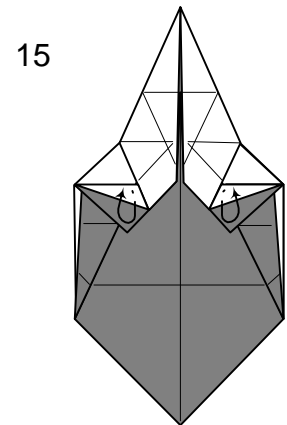
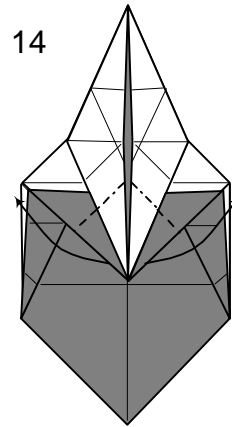
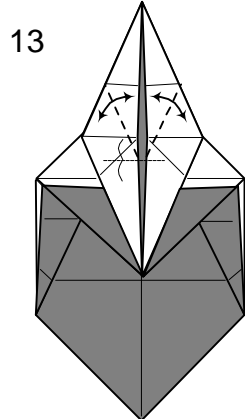
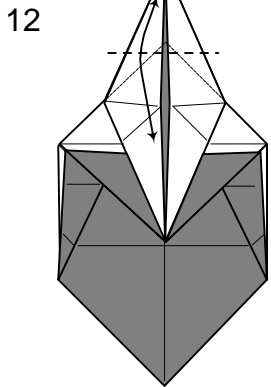

Crease tip down just a little below the point behind

Crease a single layer down to half way between the two horizontal creases

Inside reverse folds

Wrap one layer to the front (colour change)

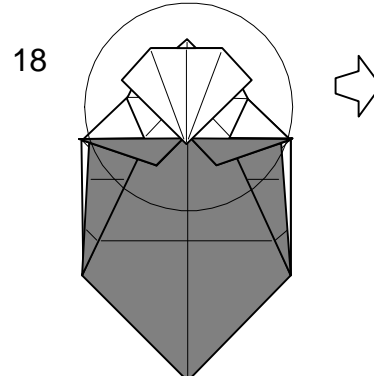
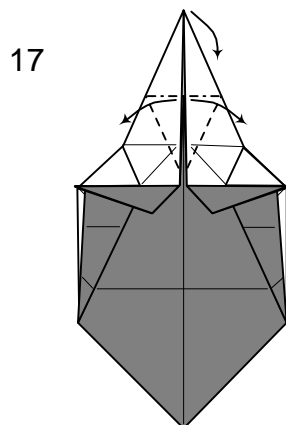
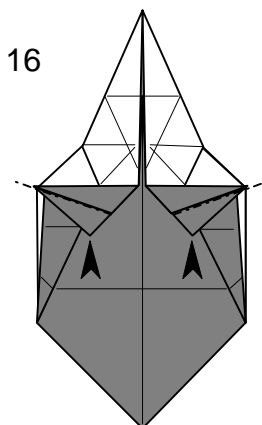

# Badger

19

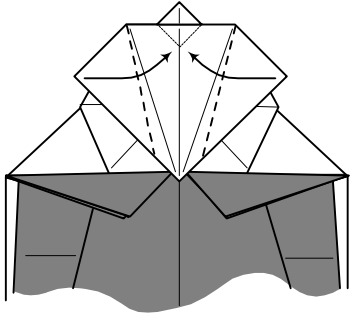

Fold sides towards the base of the 'imaginary' square

20

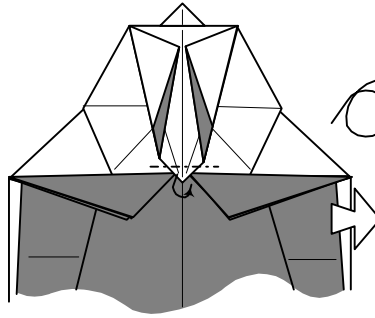

21

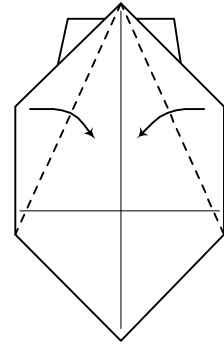

22

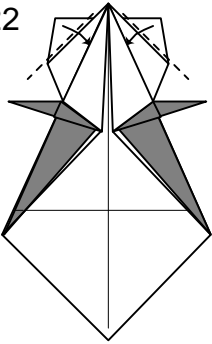

23

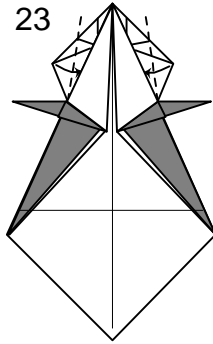

24

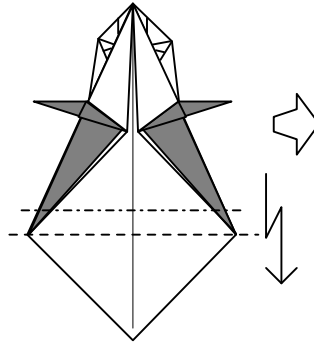

25

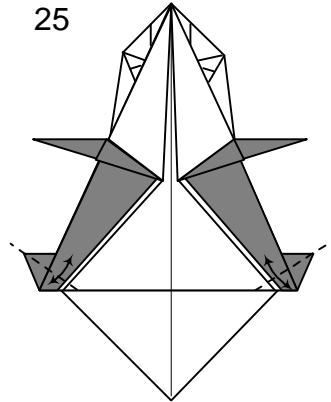

26

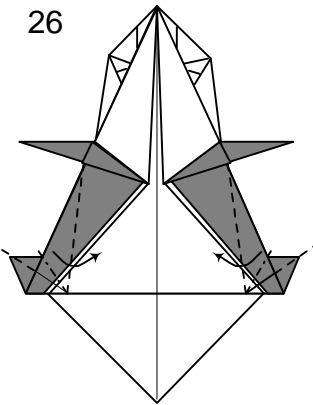

27

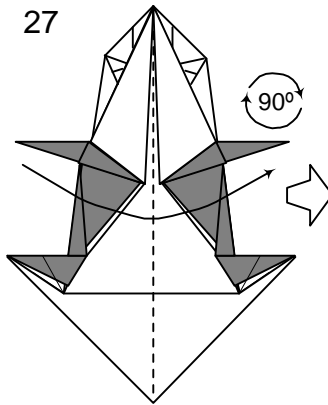

28

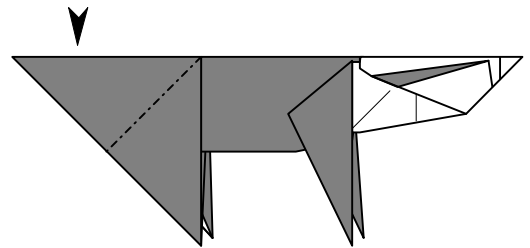

29

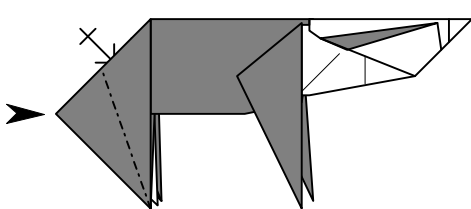

30

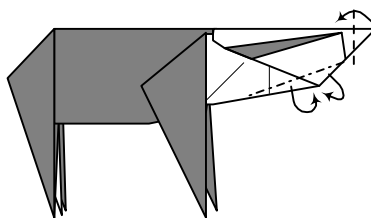

31

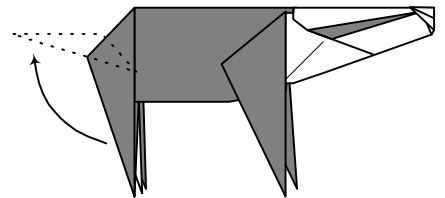

32

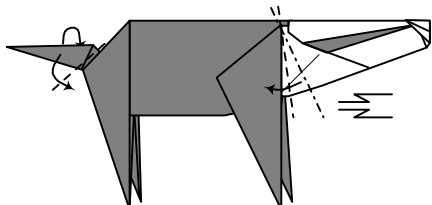

33

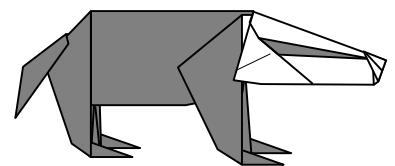
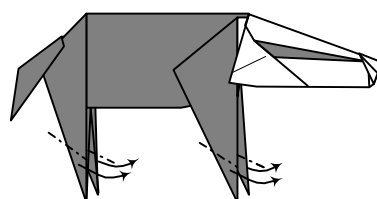

Make 4 inside reverse folds

Liens vers type 1



<http://www.ciberlibreria.info>



<http://www.cyberlibrairie.info>



<http://www.cyberlibreria.info>



<http://www.epapier.net>



<http://www.etheque.info>



<http://www.jelis.info>



<http://www.librairievirtuelle.info>



<http://www.livre-cd-gratuit.com>



<http://www.livres-electronique.com>



<http://www.telecharger-livre.com>



<http://www.webrairies.info>

# WLBrairie

La librairie du web

<http://www.webrairie.com>



Distribuez vos livres :

<http://www.webrairie.com/editeur/index.php>