

# Blue Crab / Rock Crab by Marc Kirschenbaum (NY)

©1989

Use a large foil-backed square.

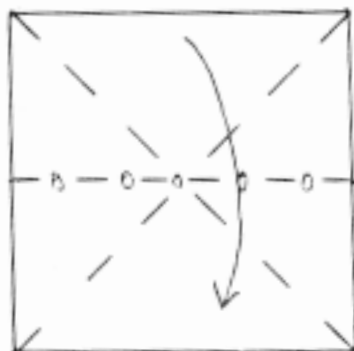

1. White side up:

Form a waterbomb base.



4. Unfold. Repeat steps 3-4 folding to the opposite side.



2. Precrease where indicated. Do not repeat behind.



3. Valley fold top corner to the intersection of creases.



5. Mountain fold through intersection of creases. (Valley fold first and convert to a mountain fold.)

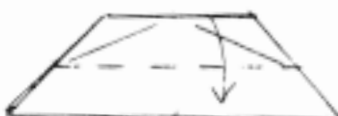

6. Valley fold the top edge to the bottom edge.



7. Unfold the pleat.



8. Unfold sides.

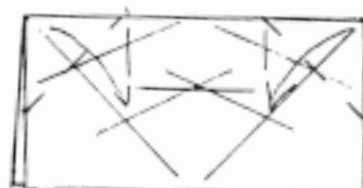

9. Valley fold where indicated.

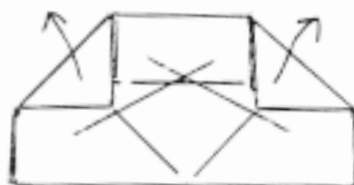

10. Unfold the two flaps.



11. Valley fold where indicated.

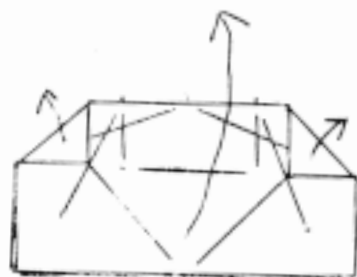

12. Convert folds from Step 11 into mountain folds, and then open up model entirely.

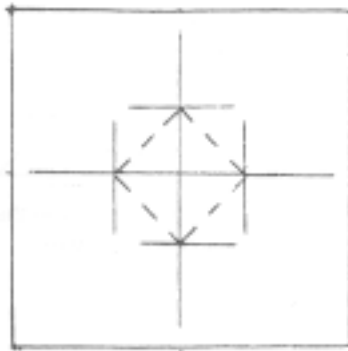

13. Precrease where indicated. Return to the waterbomb base position, being sure to keep the precreases from Step 2 in front.



14. Sink along crease from Step 5.



15. Swing down flap while squashing corners. Repeat behind and then turn over

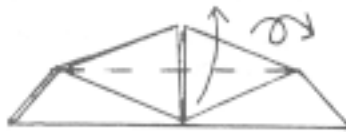

16. Swing flap up; do not repeat behind. Turn over.



17. Swing flap over.



18. Swing flap over while reverse folding on existing creases. Repeat Steps 17-18 on the other side.

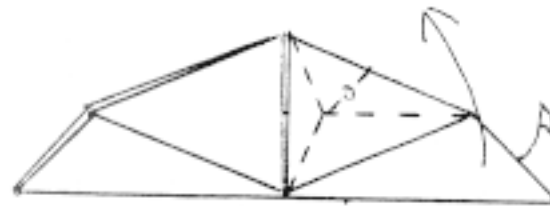

19. Model enlarged:

Rabbit ear large flap along existing creases. The two single layers in this flap will separate as a result.

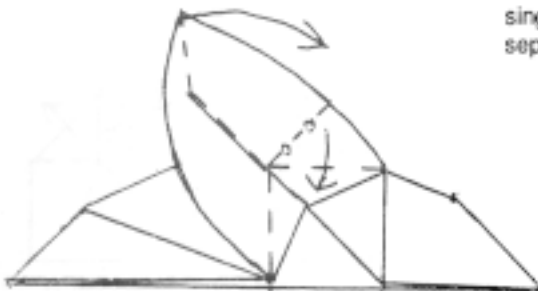

20. Swing the large flap over while bringing its single layered sides together. This is essentially a rabbit ear.

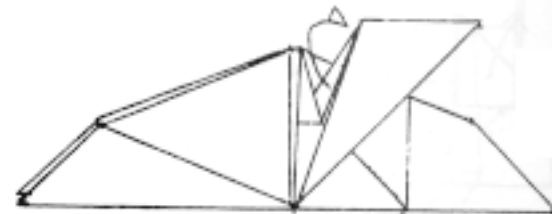

21. Wrap this layer around. The flap will have to be unfolded slightly.

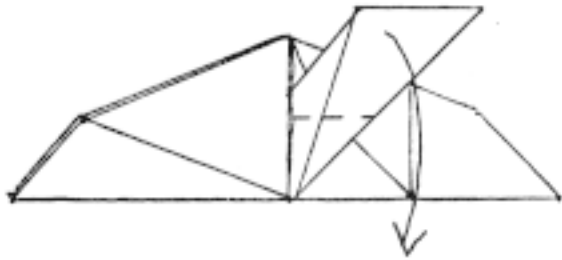

22. Swing down flap; model will not lie flat.

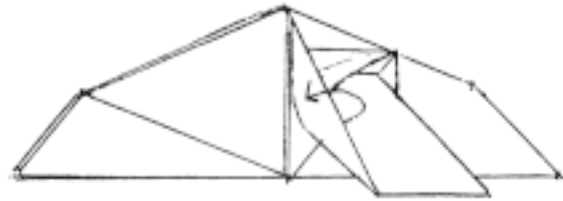

23. Pull section out and to the surface. This is essentially undoing a closed sink and then flattening.

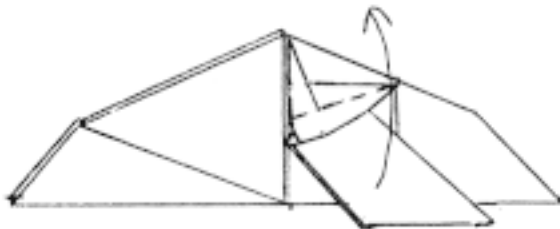

24. Step 23 completed. Swing flap back up to flatten model.

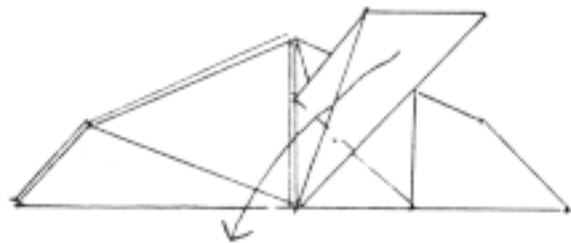

25. Swing flap across. Ensure that the layers of this flap stay together.

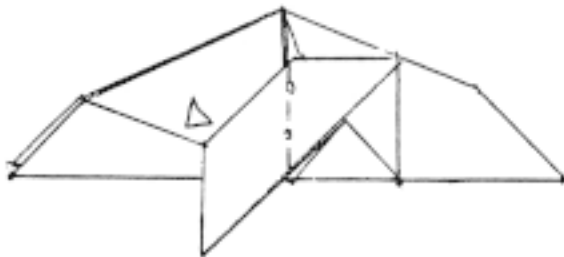

26. Closed reverse fold the flap.

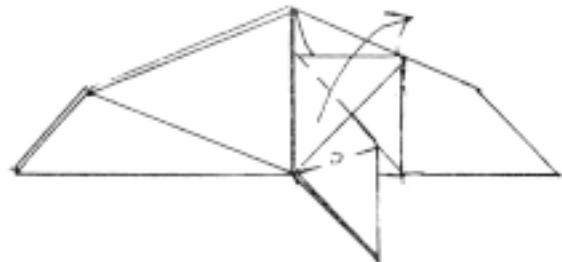

27. Squash fold the flap.

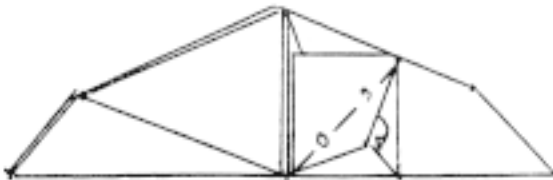

28. Mountain fold the excess paper. Repeat Steps 19-28 on the other side.

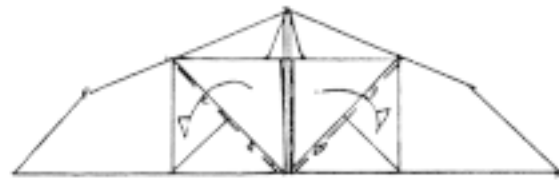

29. Mountain fold the top single layers into the model. Do not do this step if you want to make the Blue Crab.

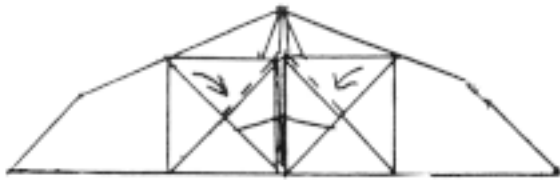

30. Swing a flap down from each side.

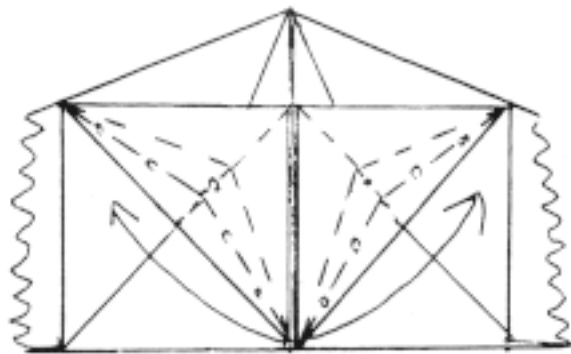

31. Detail of legs:

Swing flaps back up again, reverse folding up and then down. For Blue Crab, do not reverse fold down.

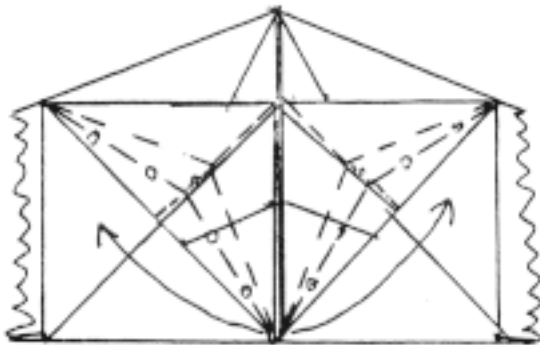

32. Same as previous step, but on a thicker flap. This time do not omit the mountain folds.

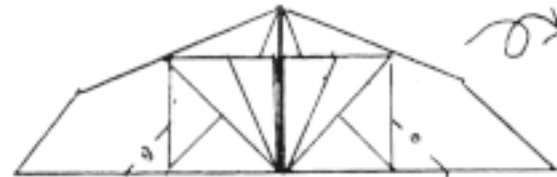

33. Precrease using the existing fold as a guide. The mountain fold should not extend to the top. Turn over.



34. Valley fold top down as lightly as possible.

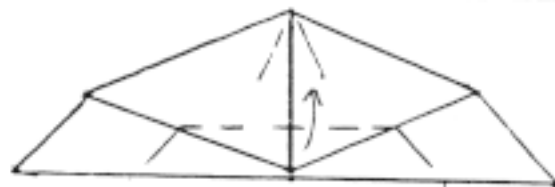

35. Valley fold flap up so that it intersects with the creases shown.

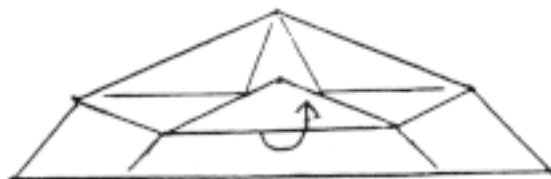

36. Pull single layer to the surface (similar to a closed sink). Do not flatten.

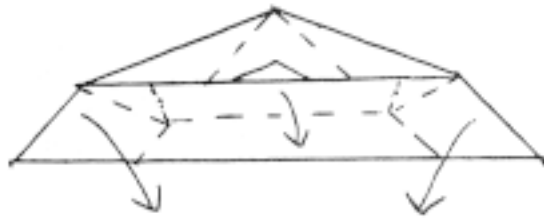

37. Simultaneously fold the sides in on existing creases while folding down the edge created in Step 36 as far down as it will go (it will not touch the bottom).



38. Turn model over.

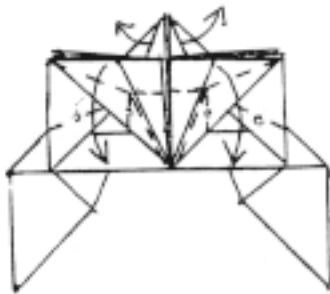

39. Pull out paper at the top of the model. At the same time, swing the legs down while collapsing the paper connecting them.

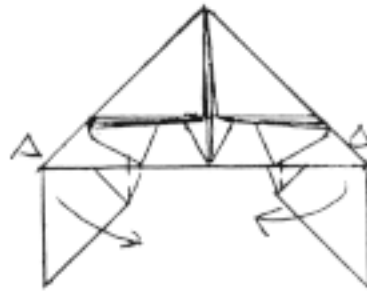

40 Reverse fold sides.

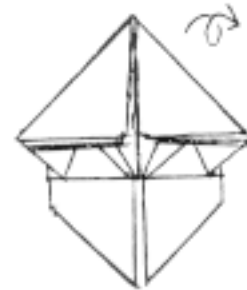

41. Turn over.

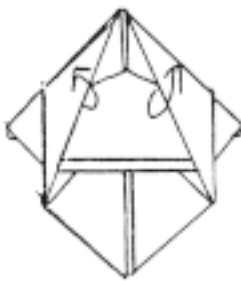

42. Bring sides to the surface (similar to undoing a closed sink).

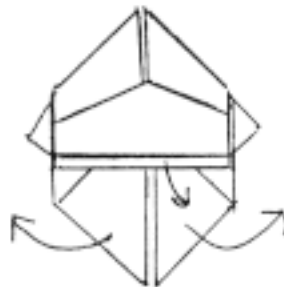

43. Spread out sides and pull out single layer; model will not lie flat.

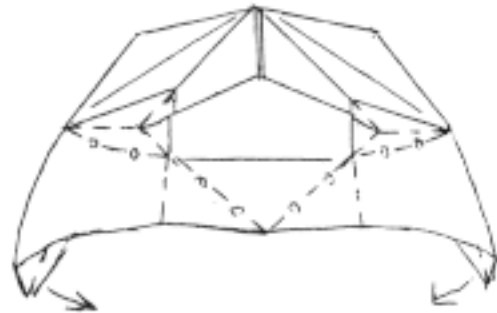

44. Collapse as shown. Please note that not all of the folds are shown; they are either partially formed or will form naturally. Also, avoid getting the legs tangled in between the layers.



45. Valley fold flap up.

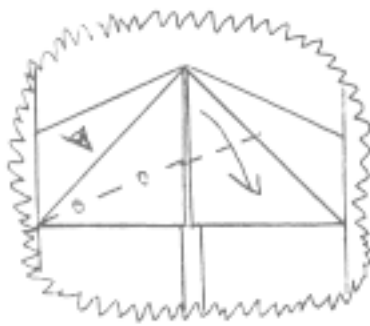

46. Enlarged view of flap for eyes:

Squash fold one side of the triangle folded up in the previous step.

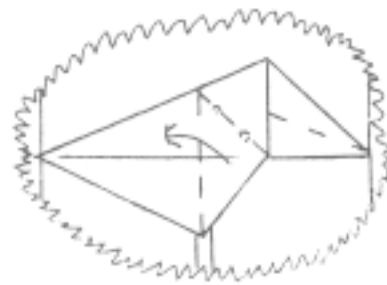

47. Form 'half' of a petal fold by swinging the small center flap over.

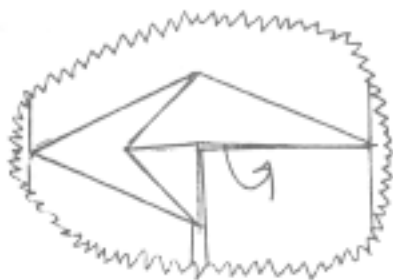

48. Pull out single layer of paper and flatten out.

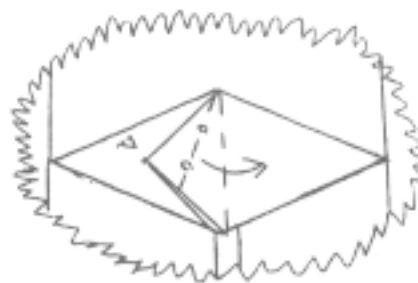

49. Squash fold flap.

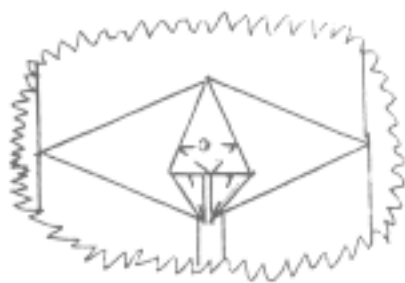

50. Fold sides in while tucking in the resulting petal fold underneath. Model should be opened up slightly to do this.

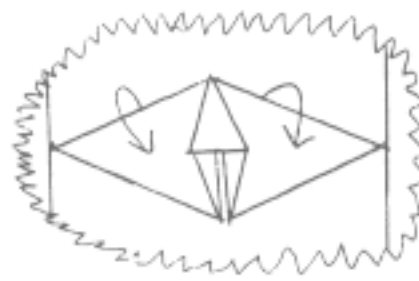

51. Pull single layer of paper over top half of eye assembly. This is essentially a closed sink.

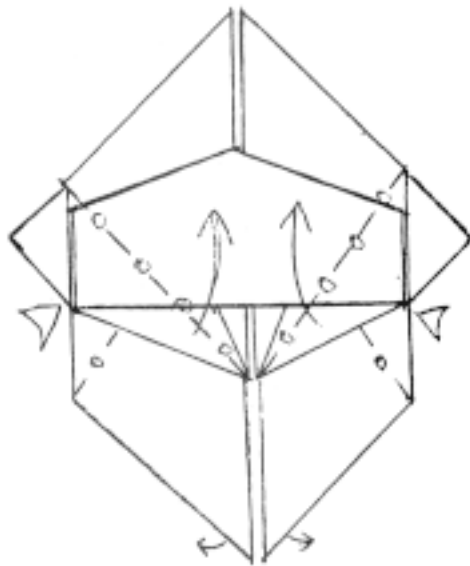

52. Sink sides. Do not flatten. Note that in the next diagram the claws move away from each other, and the raw edges on the claws do not meet the center of the model.

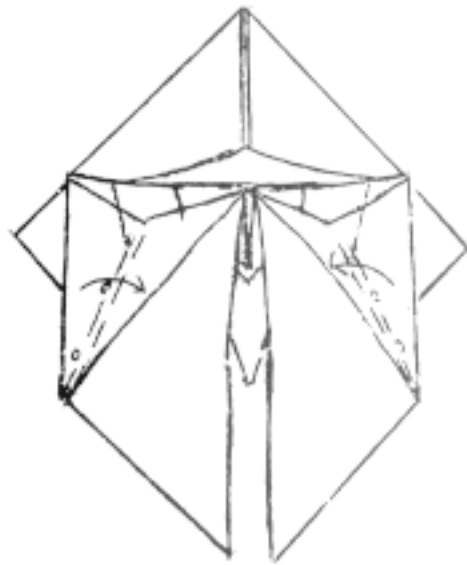

53. Make the concave sides flat by forming the tiny crimps where indicated. To accomplish this, you will first have to puff out the concave single layer from underneath.



54. Flatten model. Keep in mind that the raw edges of claws do not meet center of model, and the folded edges of claws should meet the folded edges of the crimps formed in the previous step.

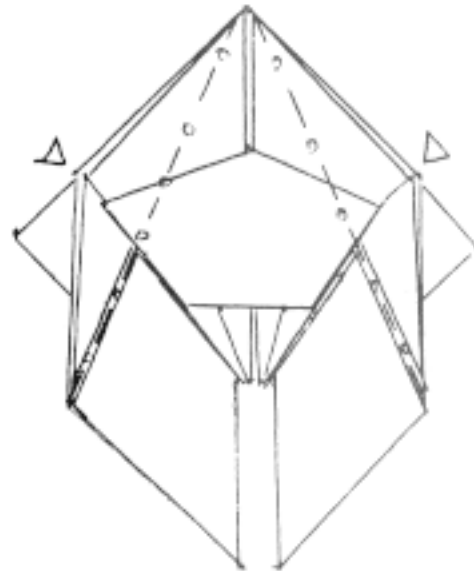

55. Closed sink where indicated. Note that model does not lie entirely flat due to tensions created by the reference points I chose.

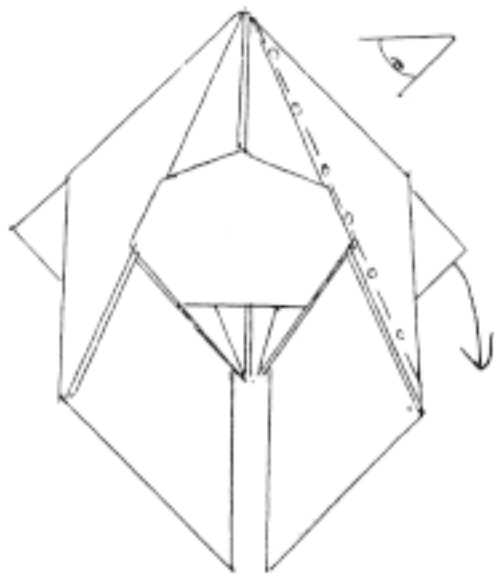

56. Open out side along indicated mountain fold. Model will not lie flat.



57. View from Step 56:

Collapse claw using folds indicated.

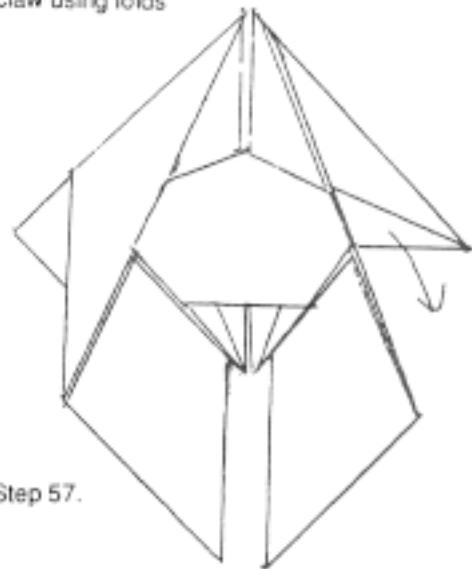

58. Complete. Return to Step 57.

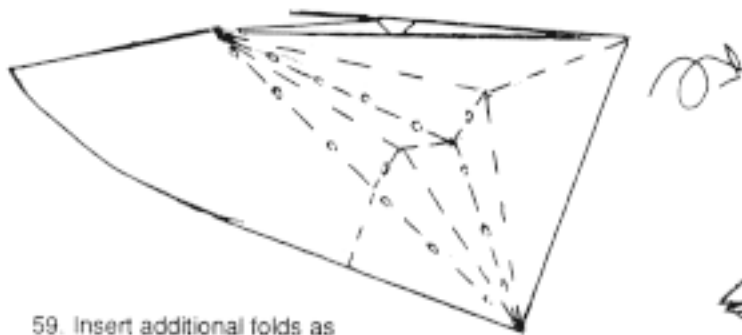

59. Insert additional folds as indicated. Completed fold will still resemble Step 58. Repeat Steps 56-59 on the other side. Turn over.

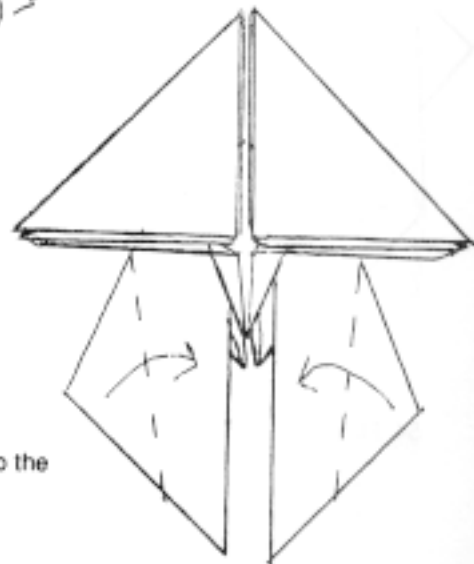

60. Valley fold corners to the nearest edge.

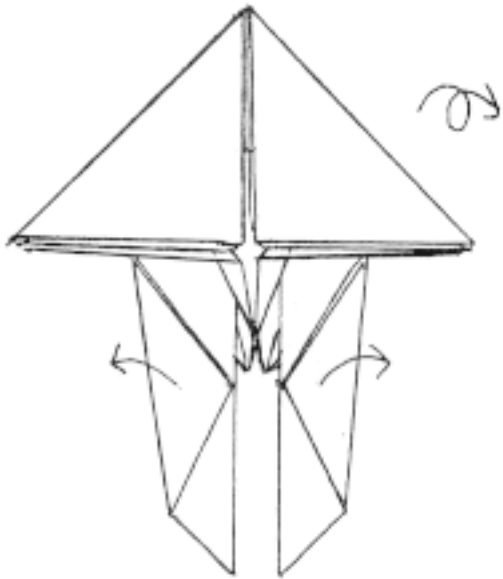

61. Unfold. Turn model over.

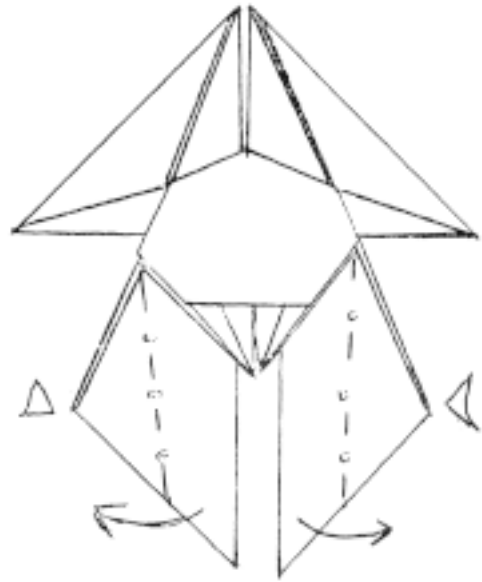

62. Sink claws while pulling them out.

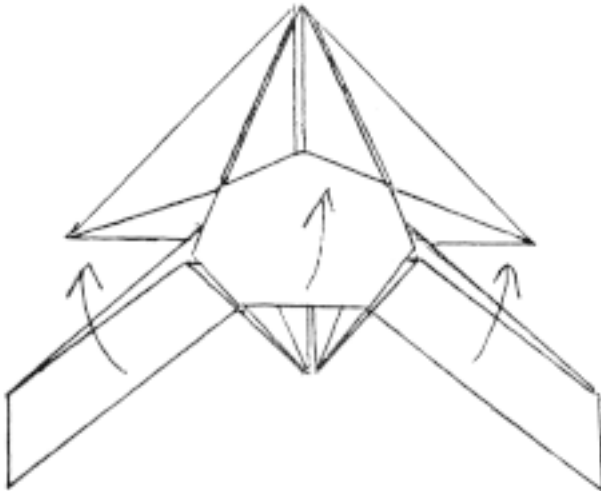

63. Raise the top layer.

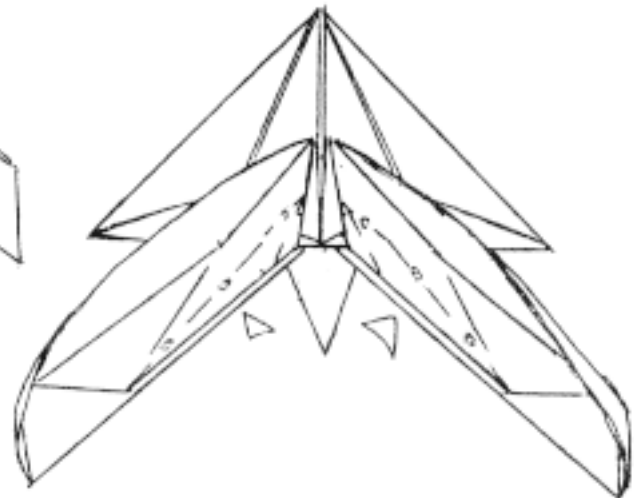

64. Sink top layer halfway towards the nearest creases.

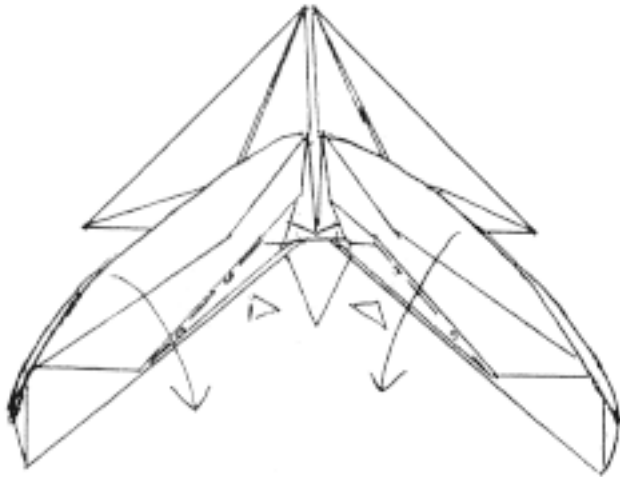

65. Closed sink the next layer down so that it lines up with its neighboring layers. Flatten model to position of Step 63.

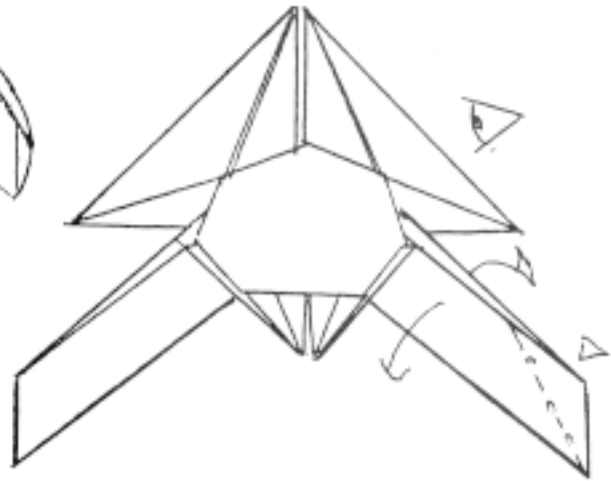

66. Spread squash the claw.

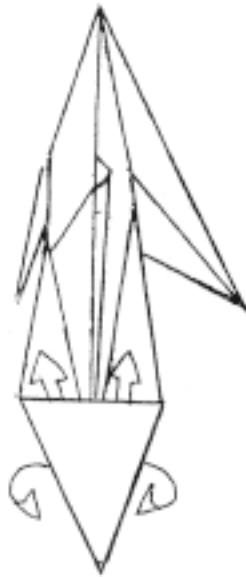

67. View from Step 66:

Unsink paper from the claw. Pull out paper from the sides of claw until its sides are straight. This will cause the claw to tilt downwards.



68. Only claw is shown:  
Mountain fold.

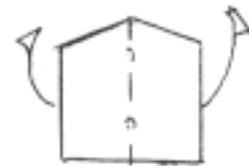

69. Flatten the claw and its arm by folding the claw in half. See the next step for the positioning of the claw.

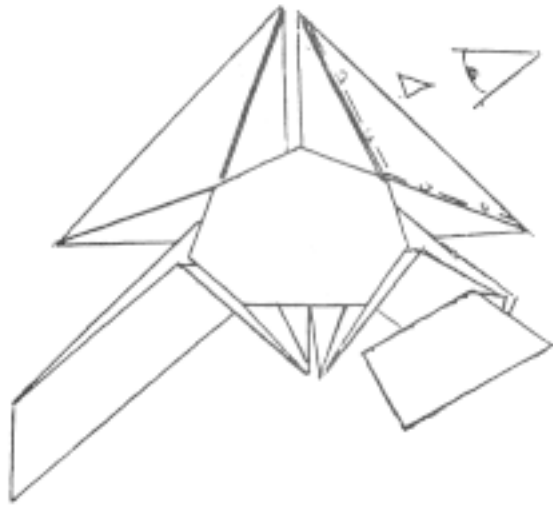

70. Repeat Steps 66-69 on the other claw. Spread apart the 'web' between the legs.

71. View from Step 70:

Insert the long valley folds in between the mountain folds and crimp the leg. The way the other folds are formed is not important. Repeat this with the other leg and then turn the model over.

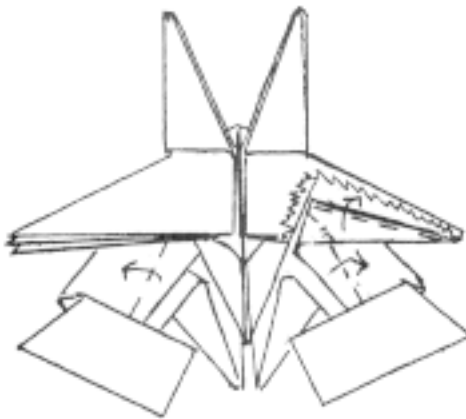
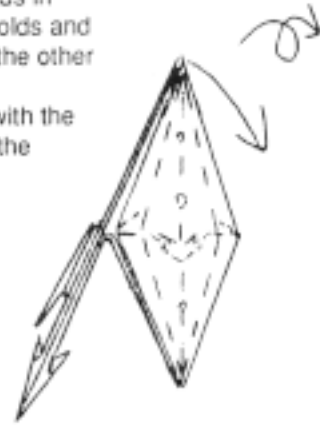

72. Swivel the bottom layer of the leg over the bottom thickness of the legs. The valley folds along the claws should lie against the thickness of pleats below them. For the Rock Crab, use a reverse fold instead; that is, use a mountain fold along the length of the legs instead of a valley fold.

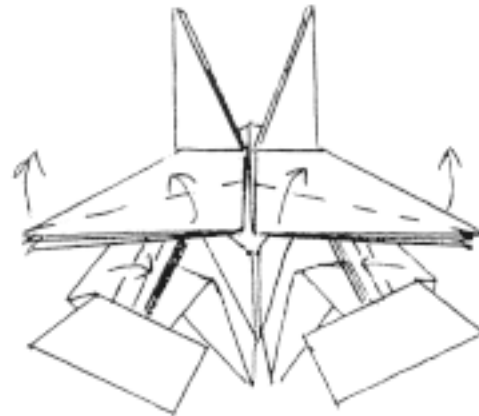

73. Valley fold the entire leg assembly in half while spreading the legs apart. The bottom single layer on the front leg should stay in place. Fold in the top layer for each of the claw's arms.

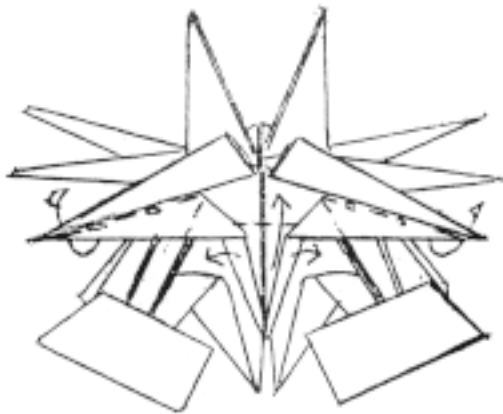

74. Squash the center flap upwards while wrapping the single layers from the legs behind. For the Blue Crab, wrap the single layers forward.

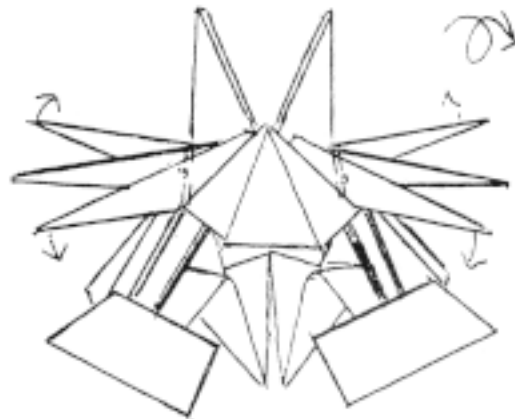

75. Completed step. Spread out legs farther, putting a slight crimp in them where they meet the body. Turn over.

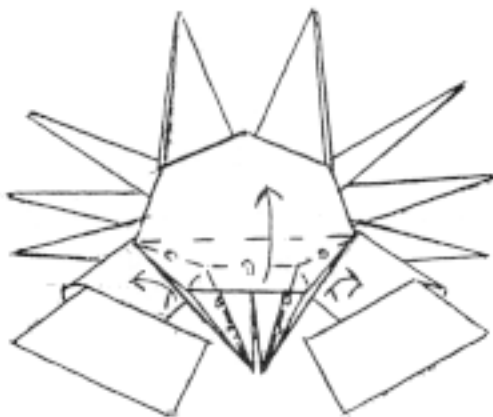

76. Squash the eyes up as indicated. The horizontal mountain fold should be made as lightly as possible. The bottom single layer of the eyes simply gets reverse folded outwards, with the fold extending down to the arms of the claws.

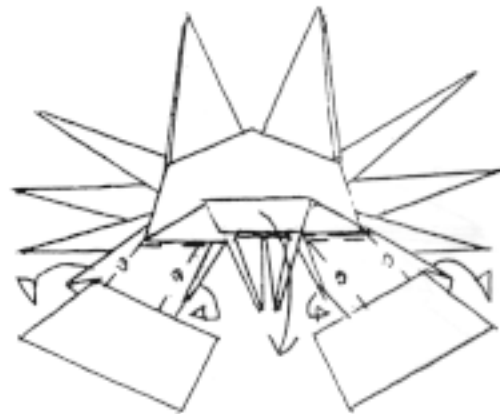

77. Fold back down the front of the shell. Pull out the eyes slightly while doing this to add to their length. Shape the arms of the claws by mountain folding them where indicated as far as possible.

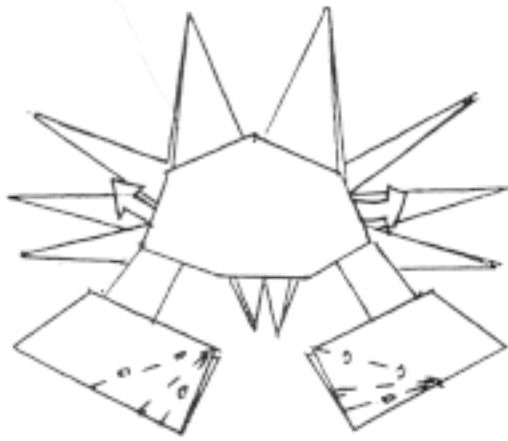

78. Reverse fold the claws in and out 3 times with each reverse fold being half the width of the previous. Pull out paper from the sides of the shell. For the Blue Crab, pull out as much as possible.

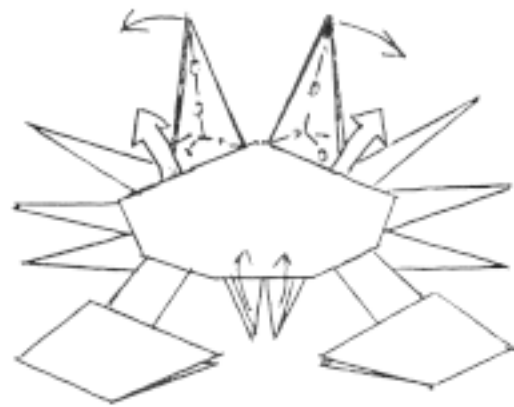

79. Pull out paper from the back of the shell. Pull out less for the Blue Crab. Rabbit ear the back legs outwards. Pinch and fold the eyes up. See the appropriate final diagram for the appropriate final shaping.

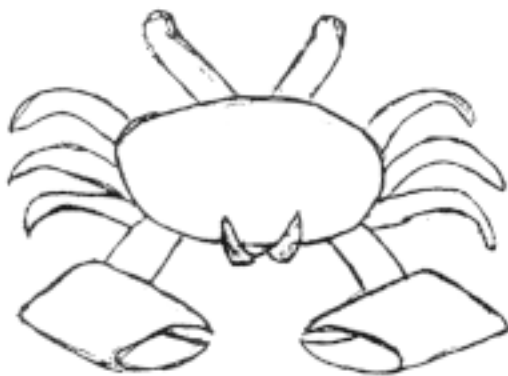

80. Completed Rock Crab:



81. Completed Blue Crab:

This model was inspired by Robert Lang's Freshwater Crab as seen in the 1986 Convention Program.

Liens vers type 1



<http://www.ciberlibreria.info>



<http://www.cyberlibrairie.info>



<http://www.cyberlibreria.info>



<http://www.epapier.net>



<http://www.etheque.info>



<http://www.jelis.info>



<http://www.librairievirtuelle.info>



<http://www.livre-cd-gratuit.com>



<http://www.livres-electronique.com>



<http://www.telecharger-livre.com>



<http://www.webrairies.info>

# WLBrairie

La librairie du web

<http://www.webrairie.com>



Distribuez vos livres :

<http://www.webrairie.com/editeur/index.php>